

**450-3359 PTFE Insulated, Thread Mount Socket,
 for .080 (2,03) Diameter Pins.**

Recommended mounting hole to suit 1/4-32 UNEF-2A thread.

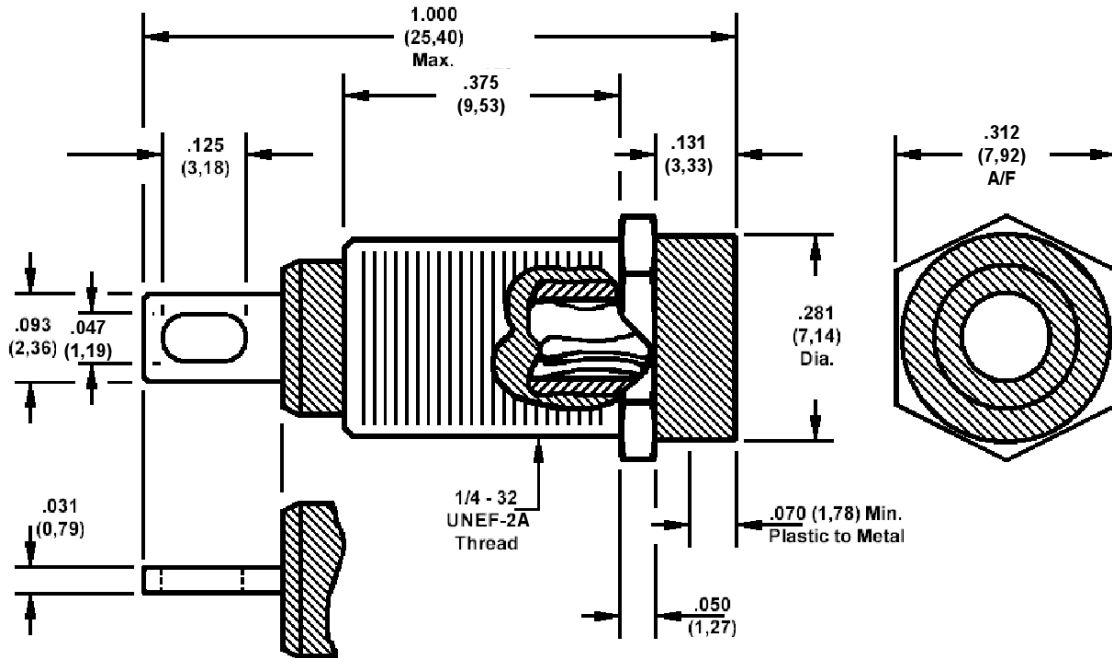

Min hole depth .540 (13,72)

How to order code
450-3359-01-03-19
Basic Part No.

MATERIALS		
Component	Material	Finish (-03)
Body	Brass	Gold over Nickel
Spring	Beryllium copper	Gold over Nickel
Metal sleeve	Brass	Nickel
Insulator	PTFE	White

Other colours to order - consult factory

Unassembled Mounting Hardware		
Component	Material	Finish
Mounting nut, hexagonal	Brass	Nickel
Internal tooth lockwasher	Phosphor bronze	Nickel

ADDITIONAL INFORMATION	
Basic Part No	Dielectric withstanding voltage (VRMS)
450-3359-01-03-XX	3000