

506-4422 Snap on colour coded cover for 450-3422 test points

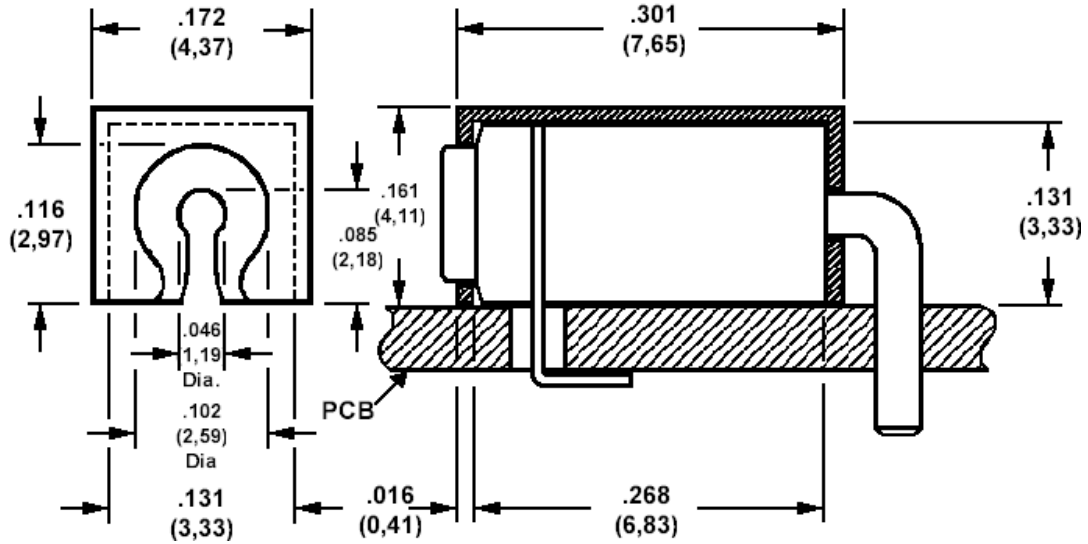

How to order code
506-4422-01-00-XX
 Basic Part No XX = Colour

MATERIALS	
Insulator	Nylon

XX - COLOURS									
-10	-11	-12	-13	-14	-15	-16	-17	-18	-19
Black	Brown	Red	Orange	Yellow	Green	Blue	Violet	Grey	White

Preferred colours in bold