

160-1464, Solder Terminal, Turreted, Feed Thru

Recommended mounting hole .120 (3,05), #31 drill

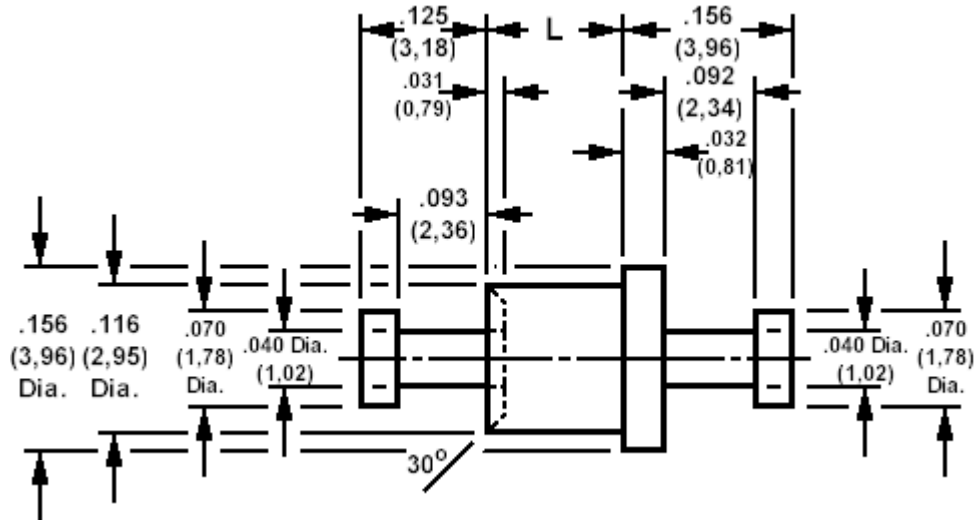

How to order code

160-1464-XX-YY-00

Basic Part No XX = L dimension, YY = Plating Finish

DIMENSIONS (XX)			
Basic Part No	(XX)	L	Board Thickness
160-1464	-02	.105 (2,67)	.062 (1,57)
	-03	.135 (3,43)	.094 (2,39)
	-04	.165 (4,19)	.125 (3,18)

MATERIALS			
Component	Material	Finish (YY)	
Terminal	Brass	-01	-05
		Silver	Electro Solder

SWAGE TOOLING	
Recommended Swaging Tools:-	
Anvil	435-6405-01-00-00
Roll punch	435-6684-01-00-00