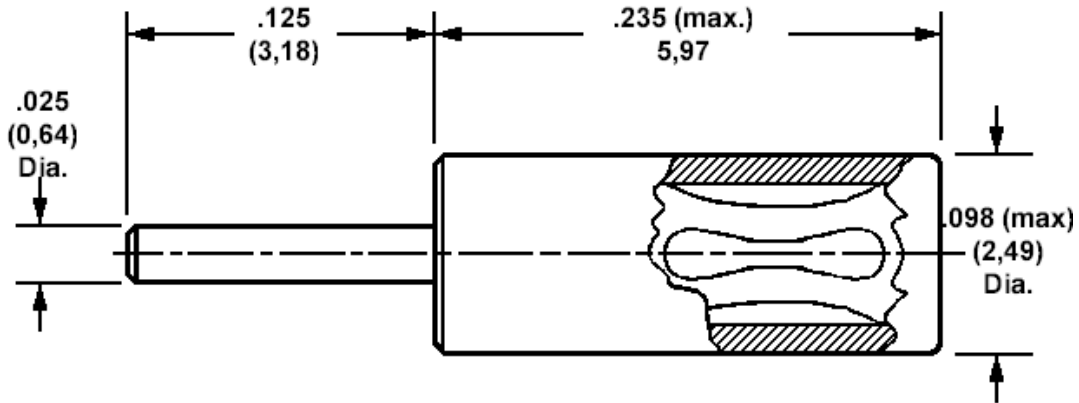

**450-3327 Converter socket, .040 (1,02) socket to .025 (0,64) pin**

Min hole depth .194 (4,95)

**How to order code**  
**450-3327-01-03-00**

Component	Material	Finish(-03)
Body	Brass	Gold over Nickel
Spring	Beryllium copper	Gold over Nickel