

570-2012 Insulated solder terminal, Feed thru

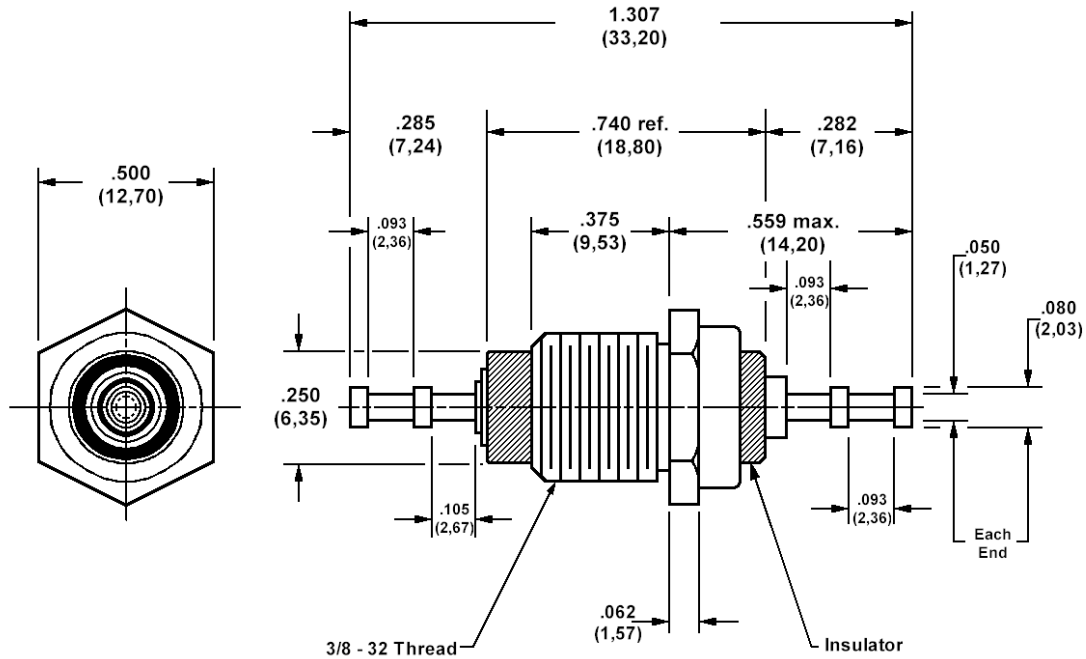

How to order code

570-2012-01-YY-00

Basic Part No (YY = plating finish. See tables for options)

Component	Material	Finish (YY)	
		-01	-05
Terminal	Brass	Silver	Electro Solder
Mounting Stud	Brass	Nickel	Nickel
Insulator	Ceramic		

Unassembled Mounting Hardware	Material	Finish
Mounting Hex Nut	Brass	Nickel
Internal Tooth Lockwasher	Phosphor Bronze	Nickel

Additional Specifications	
Dielectric Withstanding Voltage (VRMS)	3000