

570-2432 Insulated solder terminal, Slotted

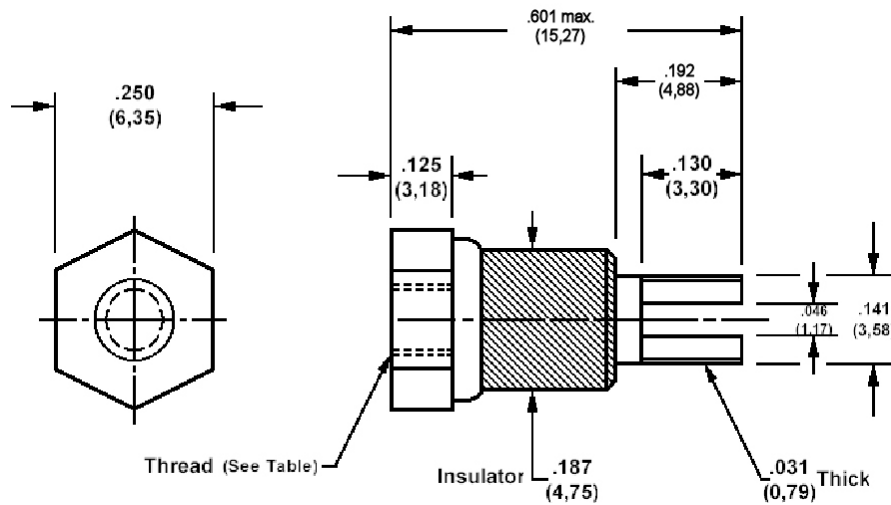

How to order code

570-2432-XX-YY-00

Basic Part No (XX = thread type, YY = plating finish. See tables for options)

Basic Part No.	XX	Thread Type
570-2432	-01	4-40
	-02	6-32

Component	Material	Finish (YY)	
		-01	-05
Terminal	Brass	Silver	Electro Solder
Stud	Brass	Cadmium (plus chromate)	Cadmium (plus chromate)
Insulator	Ceramic		

Additional Specifications	
Dielectric Withstanding Voltage (VRMS)	2500