

702-3720 Component Mounting Board, 8 pin, pitch, 0.1" (2,54) x 0.3" (7,62)

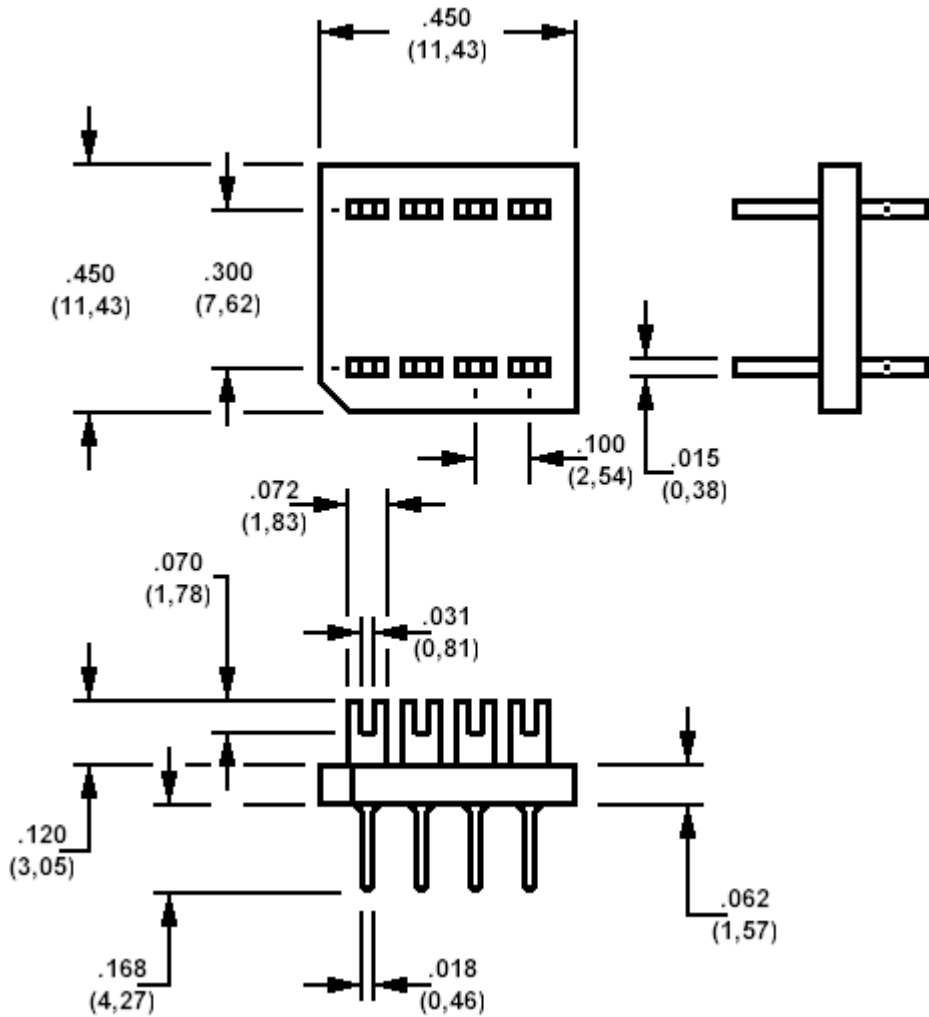

How to order code
702-3720-01-XX-00
 Basic Part No XX = Plating Finish

MATERIALS			
Component	Material	Finish (XX)	
		-03	-04
Terminal (Part # 460-2435-01-XX-00)	Phosphor Bronze	Gold	Electro Tin
Board	Glass Epoxy	-	-

FEATURES
Fibre board body for temperature withstanding during soldering
Notched corner to identify Pin